

# ISA 75x75x8

Indian Standard Equal Leg Angle -- IS 808 : 1989

## CROSS SECTION

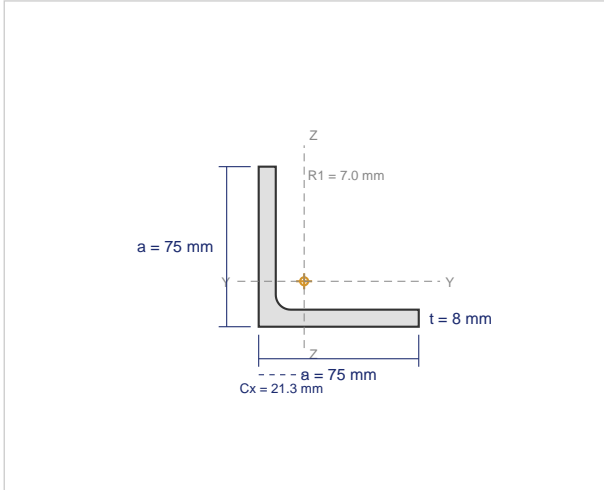

## DIMENSIONS

Leg A	75 mm
Leg B	75 mm
Thickness (t)	8 mm
Root Radius (R1)	7.0 mm
Toe Radius (R2)	3.5 mm
Centroid Cx	21.3 mm
Centroid Cy	21.3 mm
Weight per Meter	8.9 kg/m
Cross-sectional Area	1140 mm <sup>2</sup>

## SECTIONAL PROPERTIES

Property	About X-X Axis	About Y-Y Axis
Moment of Inertia	<b>Ix = 431000 mm<sup>4</sup></b>	<b>Iy = 431000 mm<sup>4</sup></b>
Elastic Section Modulus	<b>Zx = 8270 mm<sup>3</sup></b>	<b>Zy = 8270 mm<sup>3</sup></b>
Radius of Gyration	<b>rx = 19.5 mm</b>	<b>ry = 19.5 mm</b>
Centroid from Heel	<b>Cx = 21.3 mm</b>	<b>Cy = 21.3 mm</b>

## AVAILABLE GRADES (IS 2062 : 2011)

Grade	Yield (MPa)	UTS (MPa)	Elongation	Application
E250 (Fe 410W)	250	410	23%	General construction
E275 (Fe 440)	275	440	22%	Commercial buildings
E350 (Fe 490)	350	490	22%	Heavy industrial, bridges
E410 (Fe 540)	410	540	20%	Heavy structural, offshore

## APPLICABLE STANDARDS

<b>IS 808 : 1989</b>	Dimensions for hot rolled steel beam, column, channel and angle sections
<b>IS 2062 : 2011</b>	Hot rolled medium and high tensile structural steel
<b>IS 1852</b>	Tolerances for hot rolled structural steel sections