

ISA 75x50x6

Indian Standard Unequal Leg Angle -- IS 808 : 1989

CROSS SECTION

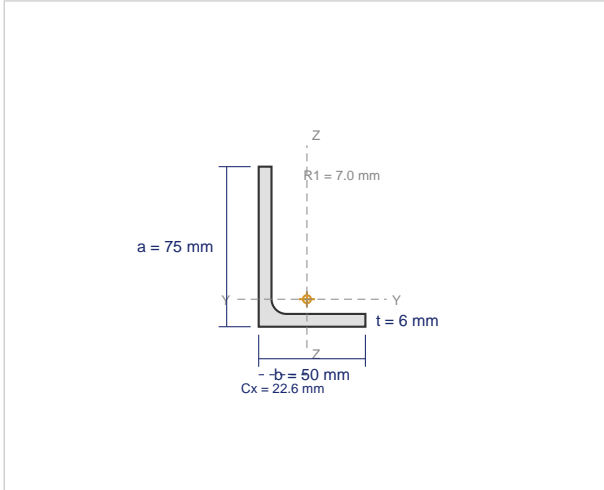

DIMENSIONS

Leg A	75 mm
Leg B	50 mm
Thickness (t)	6 mm
Root Radius (R1)	7.0 mm
Toe Radius (R2)	3.5 mm
Centroid Cx	22.6 mm
Centroid Cy	12.9 mm
Weight per Meter	5.7 kg/m
Cross-sectional Area	724 mm ²

SECTIONAL PROPERTIES

Property	About X-X Axis	About Y-Y Axis
Moment of Inertia	Ix = 246000 mm⁴	Iy = 83300 mm⁴
Elastic Section Modulus	Zx = 4680 mm³	Zy = 2380 mm³
Radius of Gyration	rx = 18.4 mm	ry = 10.7 mm
Centroid from Heel	Cx = 22.6 mm	Cy = 12.9 mm

AVAILABLE GRADES (IS 2062 : 2011)

Grade	Yield (MPa)	UTS (MPa)	Elongation	Application
E250 (Fe 410W)	250	410	23%	General construction
E275 (Fe 440)	275	440	22%	Commercial buildings
E350 (Fe 490)	350	490	22%	Heavy industrial, bridges
E410 (Fe 540)	410	540	20%	Heavy structural, offshore

APPLICABLE STANDARDS

IS 808 : 1989	Dimensions for hot rolled steel beam, column, channel and angle sections
IS 2062 : 2011	Hot rolled medium and high tensile structural steel
IS 1852	Tolerances for hot rolled structural steel sections