

ISA 200x100x15

Indian Standard Unequal Leg Angle -- IS 808 : 1989

CROSS SECTION

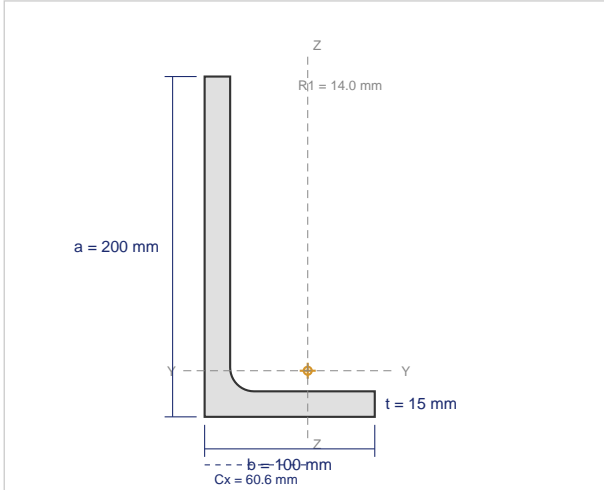

DIMENSIONS

Leg A	200 mm
Leg B	100 mm
Thickness (t)	15 mm
Root Radius (R1)	14.0 mm
Toe Radius (R2)	7.0 mm
Centroid Cx	60.6 mm
Centroid Cy	27.1 mm
Weight per Meter	33.4 kg/m
Cross-sectional Area	4250 mm ²

SECTIONAL PROPERTIES

Property	About X-X Axis	About Y-Y Axis
Moment of Inertia	I_x = 9910000 mm⁴	I_y = 1940000 mm⁴
Elastic Section Modulus	Z_x = 71500 mm³	Z_y = 27900 mm³
Radius of Gyration	r_x = 48.3 mm	r_y = 21.4 mm
Centroid from Heel	C_x = 60.6 mm	C_y = 27.1 mm

AVAILABLE GRADES (IS 2062 : 2011)

Grade	Yield (MPa)	UTS (MPa)	Elongation	Application
E250 (Fe 410W)	250	410	23%	General construction
E275 (Fe 440)	275	440	22%	Commercial buildings
E350 (Fe 490)	350	490	22%	Heavy industrial, bridges
E410 (Fe 540)	410	540	20%	Heavy structural, offshore

APPLICABLE STANDARDS

IS 808 : 1989	Dimensions for hot rolled steel beam, column, channel and angle sections
IS 2062 : 2011	Hot rolled medium and high tensile structural steel
IS 1852	Tolerances for hot rolled structural steel sections