

ISA 125x75x8

Indian Standard Unequal Leg Angle -- IS 808 : 1989

CROSS SECTION

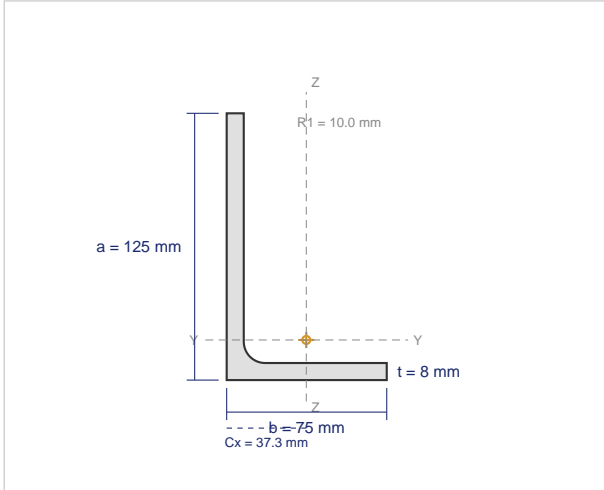

DIMENSIONS

Leg A	125 mm
Leg B	75 mm
Thickness (t)	8 mm
Root Radius (R1)	10.0 mm
Toe Radius (R2)	5.0 mm
Centroid Cx	37.3 mm
Centroid Cy	18.8 mm
Weight per Meter	12.2 kg/m
Cross-sectional Area	1550 mm ²

SECTIONAL PROPERTIES

Property	About X-X Axis	About Y-Y Axis
Moment of Inertia	I_x = 1350000 mm⁴	I_y = 361000 mm⁴
Elastic Section Modulus	Z_x = 15300 mm³	Z_y = 6860 mm³
Radius of Gyration	r_x = 29.5 mm	r_y = 15.3 mm
Centroid from Heel	C_x = 37.3 mm	C_y = 18.8 mm

AVAILABLE GRADES (IS 2062 : 2011)

Grade	Yield (MPa)	UTS (MPa)	Elongation	Application
E250 (Fe 410W)	250	410	23%	General construction
E275 (Fe 440)	275	440	22%	Commercial buildings
E350 (Fe 490)	350	490	22%	Heavy industrial, bridges
E410 (Fe 540)	410	540	20%	Heavy structural, offshore

APPLICABLE STANDARDS

IS 808 : 1989	Dimensions for hot rolled steel beam, column, channel and angle sections
IS 2062 : 2011	Hot rolled medium and high tensile structural steel
IS 1852	Tolerances for hot rolled structural steel sections